



# Quick Start Guide

## SP420 Series

4x4 Dual Band

802.11ac Wave 2 Outdoor Access Point



# Package Contents



One outdoor access point



One clamp



Waterproof cable gland (\*Note)



One ground wire



One mounting bracket + Four screws



Waterproof cable gland for fiber port (\*Note)



One quick setup guide

---

**Note:** SP420 provides two waterproof cable glands, and SP420-F provides one waterproof cable gland and one waterproof cable gland for fiber port.

---

# Installation Requirements

TERMS OF USE: All Ethernet cabling runs must use CAT5e, 24 AWG (or above) Shielded Twisted Pair (STP) cabling. In addition, please cut the cable into a proper length, strip the cables on both ends, and crimp the wires into RJ45 connectors. It is the professional installer’s responsibility to follow local country regulations, including operation within legal frequency channels, output power, indoor cabling requirements, and Dynamic Frequency Selection (DFS) requirements.

# Mounting the Access Point on the Pole

- ① Place the mounting bracket to the device using four screws (included in the packaging). Securely tighten the screws.
- ② Attach the clamp to encircle pole and the mounting bracket. Securely tighten the clamp.

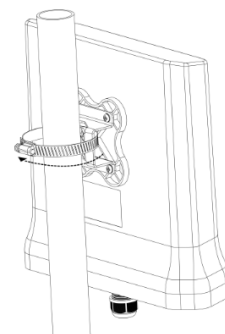
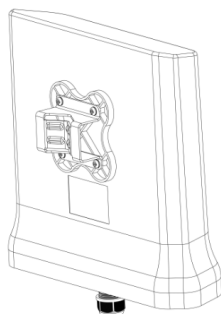
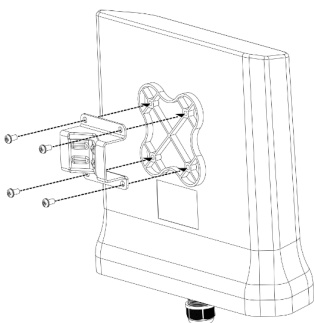

---

**Note:** Avoid having obstacles or metal plates surround the access point.

---

## Two-dimensional Mounting Kit (Optional accessory\_SP-MKM5)

### Pole-Mount

- ① Attach the intermediate steel plate to the device using four M5 screws (included in the packaging). Securely tighten the screws.
- ② Attach the two-dimensional mounting bracket to the intermediate steel plate using four M4 screws (Included in the packaging). Securely tighten the screws.

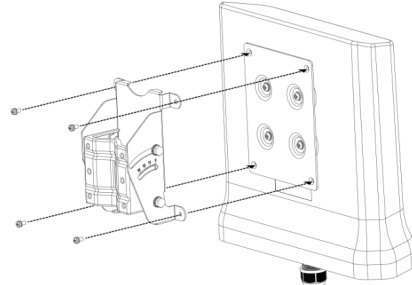
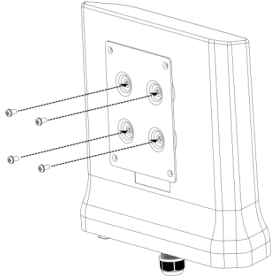

- ③ Attach the pole-supported bracket and align the area where the flat head screws will be attached. Insert two flat head screws into two-dimensional mounting bracket, and tighten them approximately.

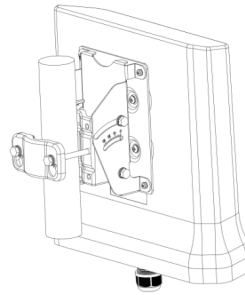
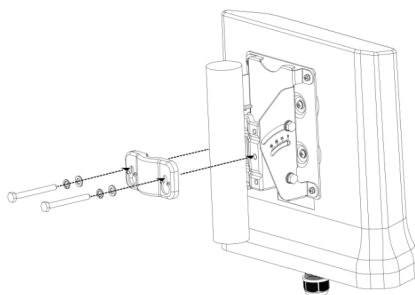

**Note:** The pole-supported bracket can accommodate up to 6 cm (2.36") in diameter.

### Wall-Mount

- ① Separate it into two parts: half-mounting bracket and M-type bracket and unscrew four hex head machine bolts on the two-dimensional mounting bracket.
- ② Attach the intermediate steel plate to the device using four M5 screws (included in the packaging). Securely tighten the screws.

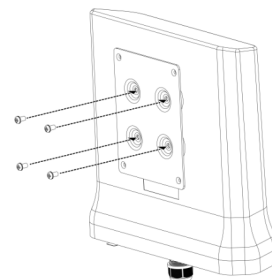
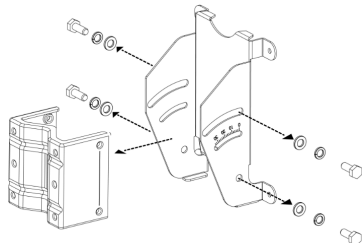

- ③ Attach half-mounting bracket to the device with intermediate steel plate using four M4 screws (Included in the packaging). Securely tighten the screws.
- ④ Attach M-type bracket to the device onto the wall, using four M5 screws + screw anchors (included in the packaging). Securely tighten the screws.

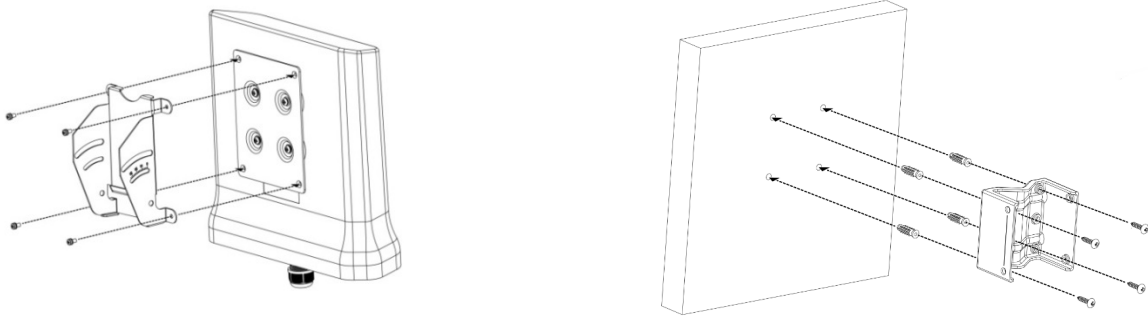

⑤ Attach half-mounting bracket to the M-type bracket, then screw four Hex head machine bolts. Securely tighten the screws.

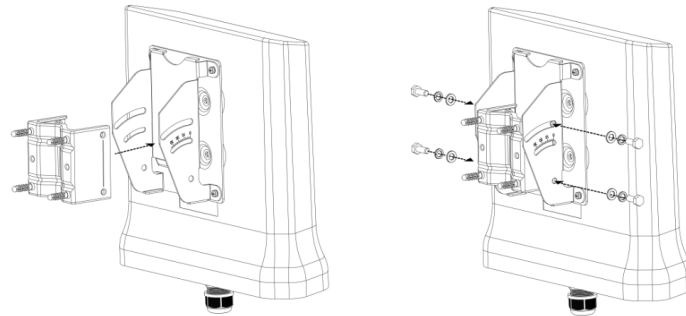

### Anti-theft steel rope (Optional accessory\_SP-CBM5)

① Insert three anti-theft screws (included in the packaging) to the device through the mounting bracket. Securely tighten these three screws. Attach the clamp to encircle pole and the mounting bracket. Securely tighten the clamp.

② Firstly, encircle the Anti-theft steel rope as following left diagram, then encircle on the pole. Secondly, insert the last anti-theft screw (included in the packaging) to the device with anti-theft steel rope. Securely tighten the screw.



### Grounding Connection & Protect from Lightning

1. Make your device GND port connect to ground wire.
2. The ground wire connects to the earth. In addition, the grounding wire meets to 6-AWG copper grounding wire.

**Note:** Be sure that grounding is available and that it must comply with local and national electrical codes. For additional lightning protection, use lightning rods and lightning arrestors.

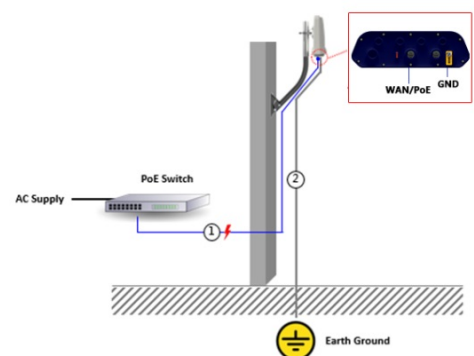

## Safety Notice

1. Do not install the device close to any electrical grounding device or lightning protection system. Place the device's own grounding and lightning protection system apart from any electrical grounding device and lightning protection system as far as possible.
2. Protect components from electrostatic discharge: Please wear an ESD wrist strap or handle the power adapter by its edge and do not touch any component or printed circuit boards, especially for module device.
3. Make sure to keep the temperature and humidity of the installation location at an optimal level.
4. An excellent grounding system guarantees the stable operation of device, as well as to protect device from lightning, interference and electrostatic discharges.
5. If installed outdoors, the device may be damaged by lightning. We recommend that you install additional lightning protection devices if necessary, considering the conditions in your area.
6. Supply stable power to the device. Unstable power may cause the device to malfunction. The device supports PoE power supply and is recommended if the device is installed near grid lines within less than 100 meters radius.

### Installing a Waterproof Cable Gland for Ethernet Port (Optional accessory\_ SP-WP-CM20)

- ① Dismantle all the components of waterproof cable gland, and plug the cable through it. Thread and assemble one by one: (1) sealing nut (2) plastic ring (3) rubber (4) locking nut. Securely tighten all the components.

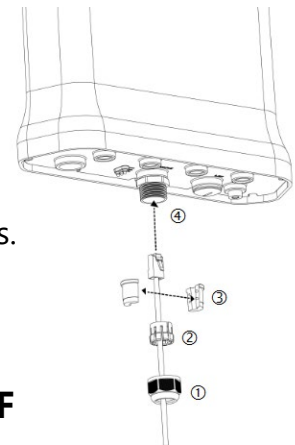

### Installing a Waterproof Cable Gland for Fiber Port of SP420-F (Optional accessory\_ SP-WP-CM28SFP)

- ① Dismantle all the components of waterproof cable gland, and plug the cable through it.
- ② Assemble all the components together; securely tighten the main unit and the sealing nut.

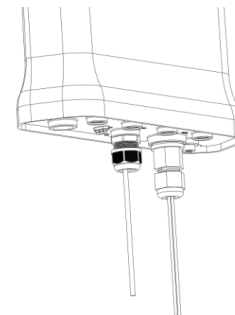
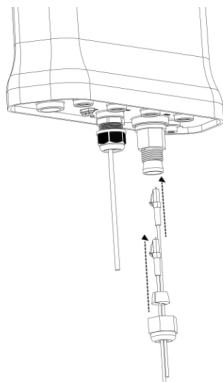

**Note:** For **SP420-F** fiber port version, it is not available for PoE Out function.



**Note:** For **SP420-F**, it is recommended to purchase 1000BASE-SX SFP transceiver module, and fiber patch cord for fiber port connection.

## Powering the Access Point

Connect the PoE cable into the WAN/PoE IN port of the device.

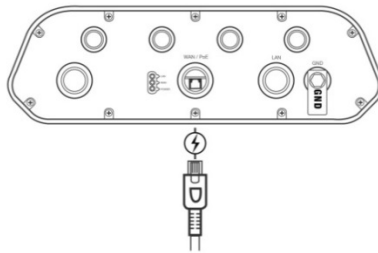

**Note:** Please wait for 5-10 seconds while powering on.



**Note:** For PoE Out applications, the LAN port provides DC 48V, Max. 208mA, and up to 10W power supply. The positive side of the 48V is connected to pin 4 and 5, the negative side is connected to pin 7 and 8.



**Warning:** Do **NOT** attempt to connect any **non-PoE** devices to LAN port and make sure the input power should comply with PoE Out standard.

## LED Indicator

Color	Indicator	Behavior	Description
Red	PWR	<b>Off</b>	Power / system off
		<b>Steady</b>	Power / system on
	WLAN	<b>Off</b>	2G and 5G WLAN interface disabled
		<b>Steady</b>	2G or 5G WLAN interface enabled
		<b>Flashing</b>	Sending / receiving data
	WAN	<b>Off</b>	No internet connection detected
		<b>Steady</b>	Internet connection detected
		<b>Flashing</b>	Sending / receiving data

## Access Point Configuration

In a default access point configuration, the access point default AP mode is TAP mode, and obtains IP addresses from DHCP Option 43 protocol.



**Note:** In TAP mode, the AP must be able to go with Wireless LAN Controllers (WLCs) for bulk configuration and performing other commands of access points. Please refer to WLC QSG for settings first, then go back to finish the AP configuration.

[https://www.zcom.com.tw/index/downloads?keyword=&material\\_type=49](https://www.zcom.com.tw/index/downloads?keyword=&material_type=49)

Step 1. Power on the access point. As the status of LED indicator from flashing change to steady red, the connection is successful.

Step 2. If the access point cannot connect to the WLC by DHCP broadcast, please refer to the following optional settings.



**Note:** Please make sure DHCP server is enabled on the network once accomplished WLC settings. The access point must receive its IP address through DHCP server.



**Note:** Switching from DHCP to assign a static IP address or DNS and L2 discovery mode to the access point, please refer to the user manual for more information.

[https://www.zcom.com.tw/index/downloads?keyword=&material\\_type=25](https://www.zcom.com.tw/index/downloads?keyword=&material_type=25)

If the access point cannot connect to the WLC by DHCP broadcast, please refer to the following optional settings.

### Optional: Set up a static IP address



**Note:** The following procedure assumes that Windows 10 is the operating system. Procedures for other operating systems are similar.

- Step 1. On your computer, configure your network adapter from the "Local Area Connection" settings as follows:
  - Start→Control Panel→Network & Internet→Change Adapter Options→Ethernet
- Step 2. Edit the TCP/IPv4 address setting as follows:
  - Properties→Internet Protocol Version 4 (TCP/IPv4)
- Step 3. Select "Use the following IP address" and make the following entries:
  - IP address: 192.168.1.168 (or any available address in the 192.168.1.x network, except 192.168.1.1)
  - Subnet mask: 255.255.255.0Leave the "Default gateway" and "DNS server" fields empty.
- Step 4. Click "OK" to save your changes.

### Login into the access point

- Step 5. Launch a Web browser; type default URL 192.168.1.1 to connect to the access point. When a security alert dialog box appears, click OK/Yes to proceed.
- Step 6. When login page appears, enter the following: Username: **root**/Password: **password**
- Step 7. Click login.

### Customizing the Wireless Settings

On the Web interface menu, Select Status→General in the menu bar. Check your switchmod item to select "Connect with via IP", and setup your WLC IP address on "Wireless Switch Address 1".



**Note:** IP address of WLC needs to be assigned (ex. 192.168.1.228) while on operation.



**Note:** If you need a standalone access point, please change to FAP mode.

### FAP Mode

The default AP mode is TAP mode, before FAP configurations please change AP mode.

- Step 1. Currently in TAP Mode: On the Web interface menu, click System→AP mode.
- Step 2. Select Fat AP from the drop-down list.
- Step 3. Click save & apply to take effect.



**Note:** For FAP mode, please refer to the user manual for more information.  
[https://www.zcom.com.tw/index/downloads?keyword=&material\\_type=25](https://www.zcom.com.tw/index/downloads?keyword=&material_type=25)

## Mobile APP

Z-COM offers the App for bridge mode settings. Please research and download it to provision.

## Technical Specifications

Physical			
<b>Dimensions (L x W x H)</b>	296 x 92 x 283 mm (11.65 x 3.62 x 11.41 in)	<b>Weight</b>	2000 grams (4.4 lbs.)
	<b>SP420</b>	<b>SP420-F</b>	
<b>WAN/PoE In Port</b>	One 10/100/1000 Mbps port	One 10/100/1000 Mbps port	
<b>LAN Port</b>	One 10/100/1000 Mbps port	One 10/100/1000 Mbps SFP	
<b>Antenna</b>	2.4GHz: Embedded 5dBi omni antennas 5GHz Embedded 5dBi omni antennas		
<b>Power Supply</b>	DC 48V, 0.5A PoE		
<b>LAN/PoE Out</b>	48V/10 Watts (Max.), Passive PoE (Pairs 4, 5+; 7, 8 Return), (SP420 Only)		
<b>Power Consumption</b>	Max. 13.5 Watts		

Environmental		
	Temperature	Humidity
<b>Operating</b>	-40°C to 70°C (-40°F to 158°F)	10% to 90% (Non-condensing)
<b>Storage</b>	-40°C to 80°C (-40°F to 168°F)	10% to 90% (Non-condensing)



# Compliance

## RF Exposure Warning

The antennas used for this transmitter must be installed to provide a separation distance of at least 20 cm from all persons and must not be located or operating in conjunction with any other antenna or transmitter.

## CE Marking

CE marking on this product represents the product is in compliance with all directives that are applicable to it.



---

**Note:** This device meets Max. TX power limit per ETSI regulations.

---

## WEEE Compliance Statement



European Directive 2012/19/EU requires that the equipment bearing this symbol on the product and/ or its packaging must not be disposed of with unsorted municipal waste. The symbol indicates that this product should be disposed of separately from regular household waste streams. It is your responsibility to dispose of this and other electric and electronic equipment via designated collection facilities appointed by the government or local authorities. Correct disposal and recycling will help prevent potential negative consequences to the environment and human health. For more detailed information about the disposal of your old equipment, please contact your local authorities, waste disposal service, or the shop where you purchased the product.





## Declaration of Conformity

Hereby, Z-COM, Inc. declares that the radio devices are in compliance with Directive 2014/53/EU.

The full text of the EU declaration of conformity is available at the following internet address:

[https://www.zcom.com.tw/index/downloads?keyword=&material\\_type=56](https://www.zcom.com.tw/index/downloads?keyword=&material_type=56)

## Optional Accessories

PN	Item	Picture	SP420	SP420-F
SP-CBM5	Anti-theft steel rope + allen wrench + four screws		V	V
SP-MKM5	Two-dimensional mounting kit <ul style="list-style-type: none"> <li>• Two-dimensional mounting bracket</li> <li>• Pole-supported bracket</li> <li>• Intermediate steel plate</li> <li>• Two flat head screws</li> <li>• Four self-tapping screws</li> <li>• Four screw anchors</li> <li>• Four machine screws (M4)</li> <li>• Four machine screws (M5)</li> </ul>		V	V
SP-WP-CM20	Waterproof cable gland		V	V
SP-WP-CM28SFP	Waterproof cable gland for fiber port			V
SP-48063-XX	48V PoE Injector + power code		V	V



**Note:** When ordering power adaptors, you must specify the destination region by indicating -US, -EU instead of -XX.

## Contact Information

All information may be changed by Z-COM at any time without prior notice or explanation to the user. For further information please refer to our website: [www.zcom.com.tw](http://www.zcom.com.tw)

**Z-COM, Inc.**

5F, No. 8, Hsin-Ann Road, Hsinchu Science Park, Hsinchu, Taiwan

Tel.: +886 35777364 Fax: +886 35773359

[www.zcom.com.tw](http://www.zcom.com.tw)

